



MVAdvanced®

Portable Paperless Recorder

MV1000/MV2000

www.mv1000.com

Introducing the portable recorder with evolutionary high reliability and ease-of-use!

Measurement scenarios that call for speed and accuracy: MVAdvanced accurately captures precious evaluation data on the test bench and in the field, and helps to cut down on manhours.

Easy Setup

The simplified interface lets you start measuring sooner!

Reliable Recording

You can now record even more channels over even longer durations

Smart Analysis

Improved PC compatibility ensures a smooth transition into data analysis!

Easy-to-read Display

Incredibly clear LCD monitor.
Improved monitor interface!

- Multi-point Input** Best-in-Class
 MV1000: 24-channel input
 MV2000: 48-channel input
- Reliable Long-duration Memory** Best-in-Class
 Internal memory: 400 MB
 (Approximately 148-day continuous 12-channel measurement data storage at a 1-second data storage interval)
 Data can be stored in external storage media, such as a CF card and USB memory.
- Wide Range of Input Types**
 Accepts thermocouple (up to 18 types), RTD (up to 12 types), DC voltage (within ± 50 V), and contact inputs.
- Insulated between channels, 1000 VAC withstand voltage!**
- The Text Save mode enables text data to be transferred directly to general-purpose software.**
- New aluminum body reduced the weight by approximately 20% (MV2000).**
- A wealth of network functionality such as E-mail, FTP, and DHCP functions are available.**
- Setup is fast and so easy that no manual is required.**
- Removable input terminals make wiring easier.**

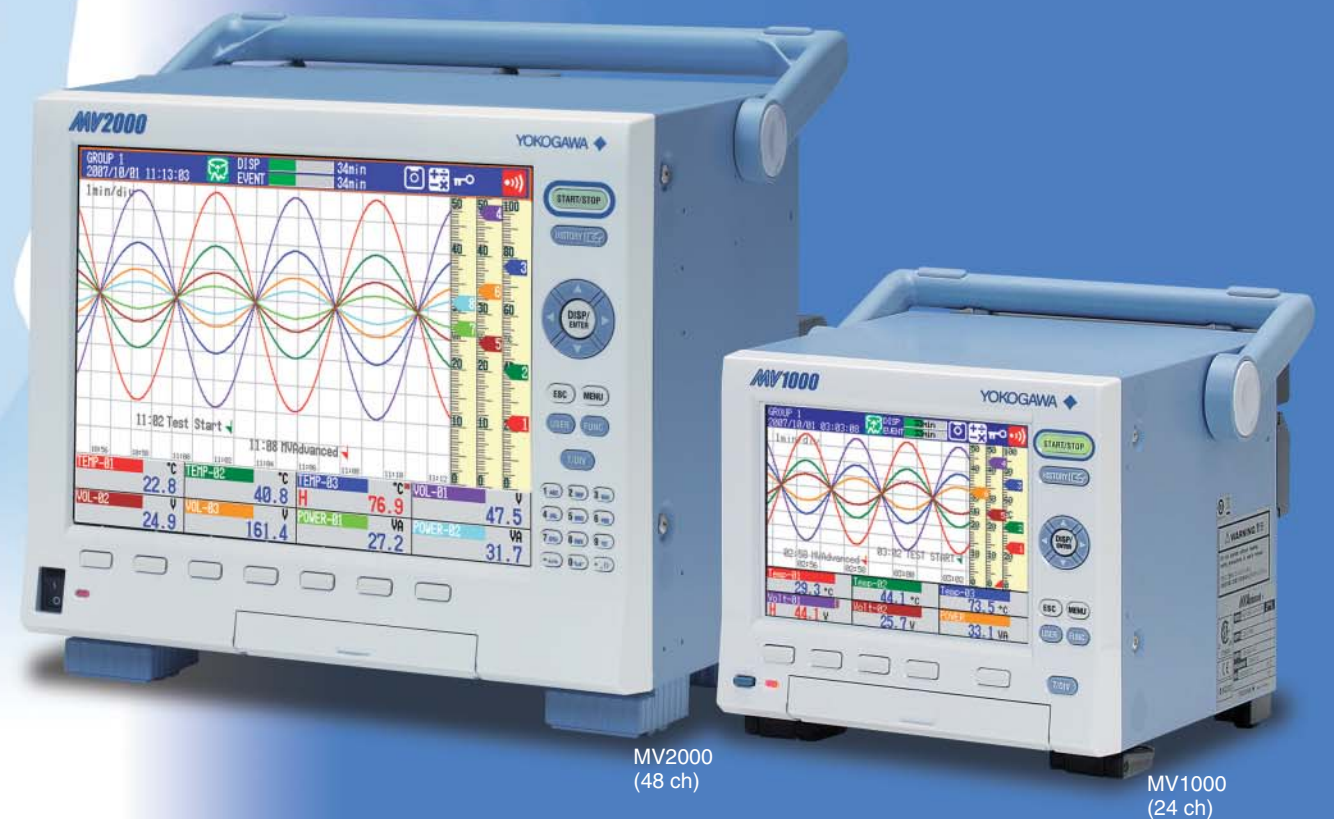

MVAdvanced®

MV1000/MV2000

Easy Setup



The simplified interface lets you start measuring sooner!



■ Quick Setup mode

We have put all the essential measuring options in one place. Setup is so simple and easy that there is no need for a manual.

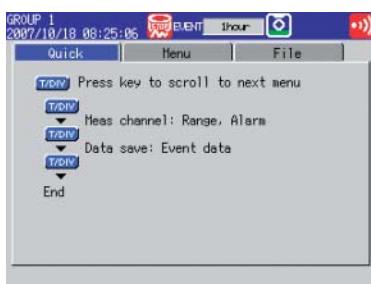

■ USB equipped

Comes standard-equipped with two USB ports. You can download setup files from your PC and save measured data with the touch of a button.



■ Removable input terminals

Input terminals can be removed in units of 2 channels, making wiring much easier. And block terminals can be purchased separately.



■ Acquire the data you need with a variety of measuring modes

The MV1000 and MV2000 are loaded with a variety of measurement features. By matching these features to your measurement goals, you are sure to be able to collect the data you need.

● Free mode

Data acquisition is user prompted, and acquisition of the data sequence occurs at the set sampling rate.

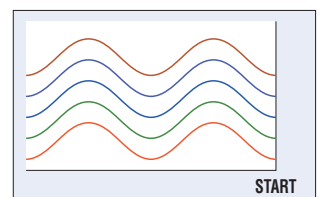

● Trigger modes

You can use a variety of triggers—such as alarm, external contact, time, and calculated data—to set the timing of data acquisition. By combining these with pre-trigger functions and other features, you can efficiently acquire the data you need.

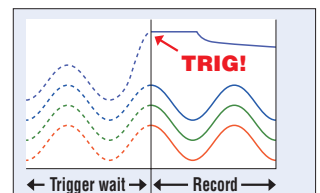

Reliable Recording

You can now record even more channels over even longer durations!



Multi-channel input

The MV1000 can support up to 24 channels (2 times as many channels as before), while the MV2000 can support up to 48 (1.6 times as many channels as before)! Naturally, every channel is isolated, and you can count on reliable data acquisition!

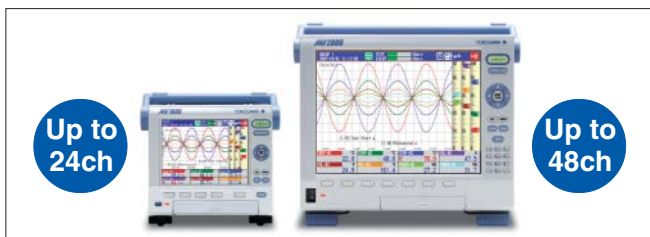

High-capacity memory

Equipped with 400 MB (330 times more memory than before) of internal flash memory! By backing up with external media (CF card), you can further ensure the safety of your data!

If a power outage should occur, then the unit will automatically resume measurement when power returns.

Example of saving data to internal memory*

MVAdvanced 400 MB  Approx. 148 days

*Condition
 • Sampling interval: 1 sec
 • Measurement channel: 12 ch
 • Binary save mode

High-speed sampling

By measuring in high-speed mode, you can attain a minimum measurement interval of 25 ms for every channel (MV1004, MV1008, and MV2008). With a measurement interval that is 5 times faster than before, you can acquire more detailed data.

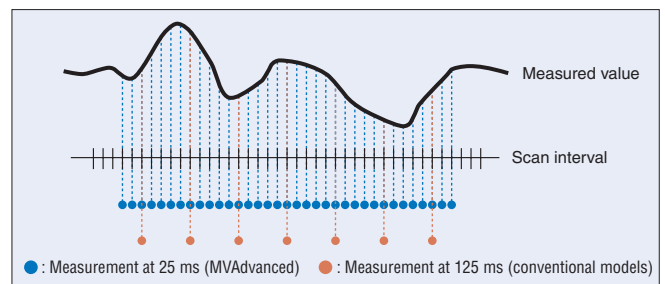

External input gives you up to 348 channels

By connecting to the DAQMASTER Series MW100, you can increase channel input by a maximum of 300 channels. Connection is as easy as the touch of a button!

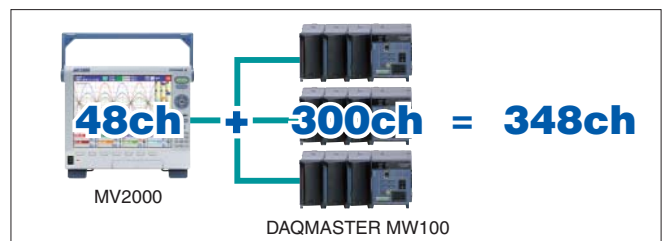

Easy-to-read Display

Incredibly clear LCD monitor.
Improved monitor interface!

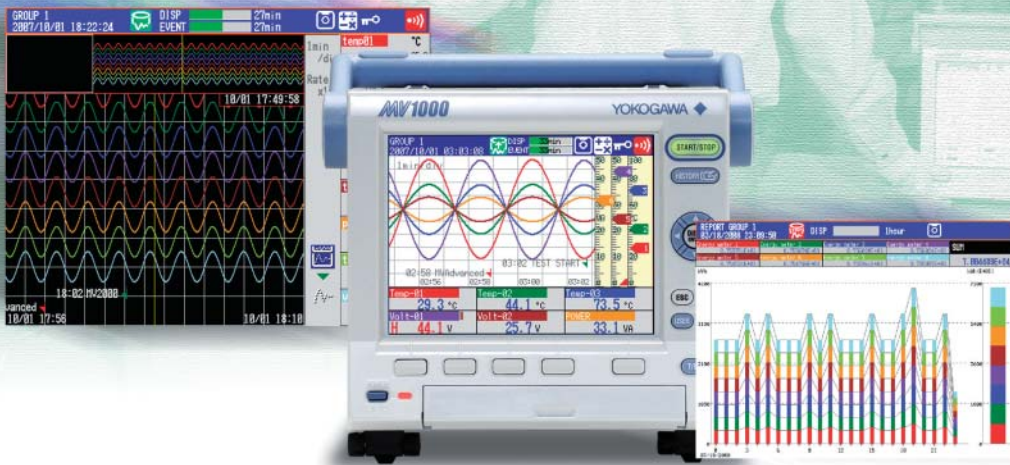

Incredibly clear wide-angle LCD monitor

With a wider viewing angle and a well-defined, vivid display, we have dramatically improved the viewing experience.

We have also included brightness adjustment and screen saving features.

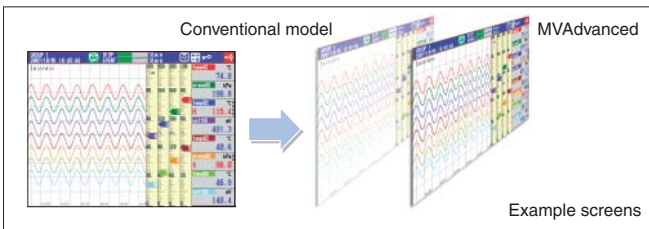

Full of display features you can use

- Display rate change
- Auto span display
- Pause function
- High-speed scroll
- Fine grid function
- Top display function
- Relative time display
- Auto zone display

Integral bar graph display

For example, when connecting to a flow meter or a power monitor, you can use bar graphs to check integrated values!

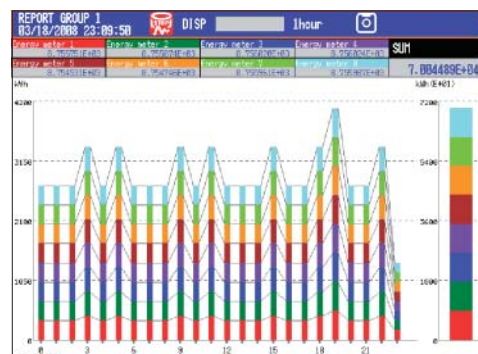

Smart Analysis

Improved PC compatibility ensures a smooth transition into data analysis!



Text save mode

Data measured using the MV1000/MV2000 can be saved in text format to a CF card or to USB memory. This enables you to view data directly without using dedicated software. If you are concerned with security, the option to save data in binary format is also available.

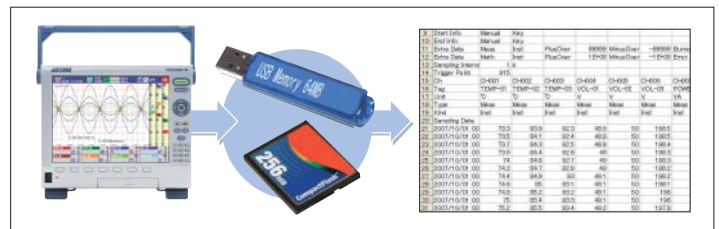

Application software [DAQSTANDARD DXA120]

This is the software package that comes standard with the MVAdvanced. You can use your PC to analyze data saved on the MVAdvanced. You can also arrange settings on your PC and download them to the unit.

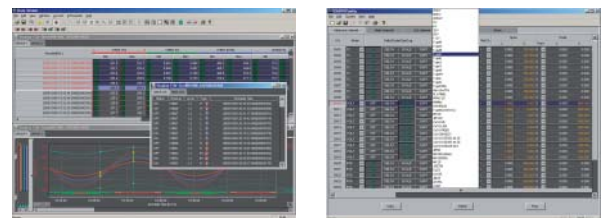

Package software [DAQWORX]

DAQWORX is a software package that enables you to integrate the Yokogawa recorders, data loggers, and controllers in your data acquisition system. DAQWORX enables you to build a system that can handle anything from small scale networks to distributed multi-channel data acquisition.

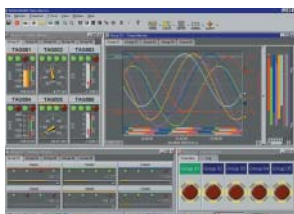

DAQLOGGER

A data logging software program that enables you to use the Ethernet and serial communication simultaneously. You can combine up to 32 machines, such as the MVAdvanced, DXAdvanced, DARWIN, and μ R recorder for a total of 1600 channels of data acquisition.



DAQEXPLORER

This is a software package that, on top of the features of the DAQSTANDARD package, also has both file transfer and PC monitoring functions. You can easily make full use of the MVAdvanced's wide range of networking features.

Hardware to ensure reliability

Rotatable handle

Designed for easy hand carrying. The rotatable handle allows for easy storage.

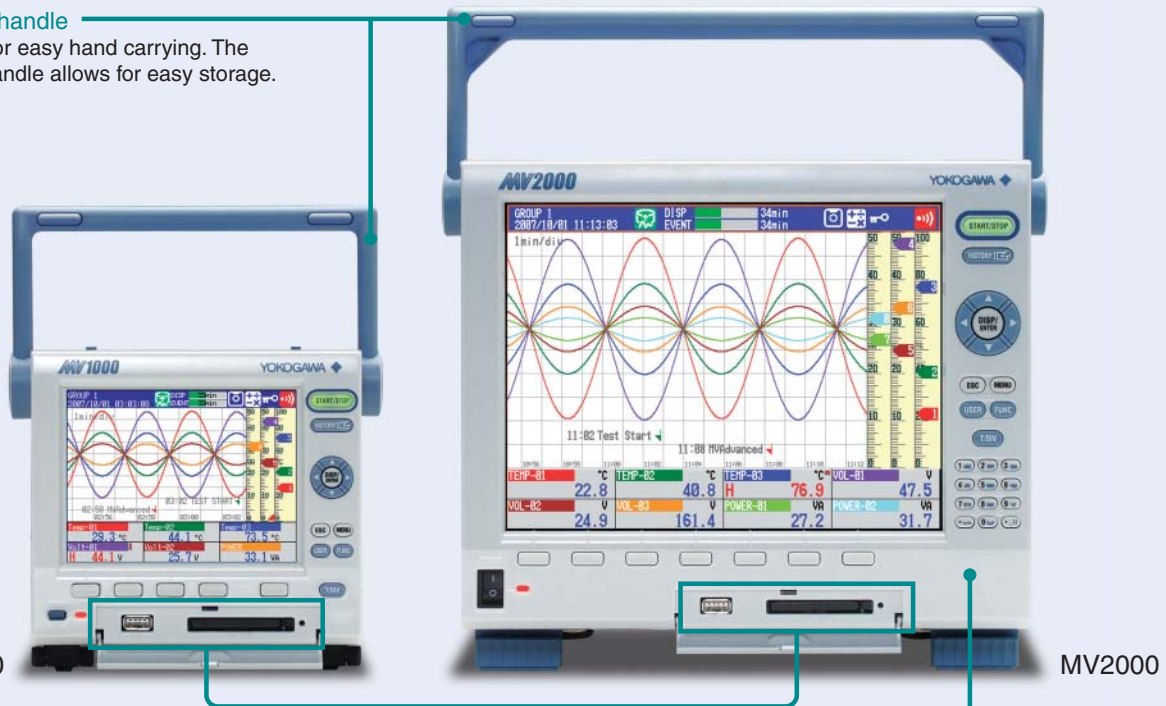

Storage media slots (CF Card and USB port)

CF card slot

Highly-reliable, and easy-to-use CompactFlash cards serve as the external media. Up to 1GB CF cards are available as optional accessories.

USB slot

Using the USB interface, you can save data to USB memory. With easy-to-use USB memory, data transfer to a PC is simpler than ever.

Lightweight aluminum body

Featuring a lightweight aluminum case, the MV2000 is now 20% lighter than previous models.

Isolated channel inputs

DC voltage and thermocouple inputs in all MVAAdvanced models are channel-isolated. (Channel isolation for RTD inputs is optional on some models.) The high common mode noise characteristic enabled by isolated channel inputs ensures stable measurements in a wide range of applications.

Signal input circuit diagram

(The dotted section are isolated.)*
* If the three-wire isolated RTD input is specified, the b terminal is also isolated between channels.

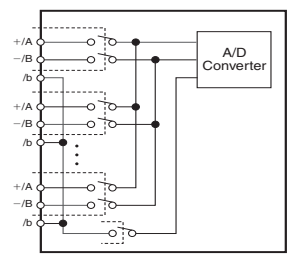

High-breakdown-voltage solid-state relays

MVAAdvanced uses high-breakdown-voltage solid-state relays developed by Yokogawa as scanners for switching input signals. These relays consist of MOSFETs capable of withstanding high voltage (1500 V DC) with low leakage current (3 nA), and power-output photocouplers. They provide high-speed scanning (125 ms/48 channels in the MV2048) while increasing scanner life and eliminating noise.



Compliance with safety standards and EMC standards

Another indication of the reliability of MVAAdvanced is their compliance with the stringent specifications for international safety and electromagnetic compatibility (EMC) standards. Of course, MVAAdvanced have also been approved for the CE standards.



Yokogawa EMC laboratory

CSA: CSA22.2 No61010-1, installation category II, pollution degree 2

UL: UL61010-1 (CSA NRTL/C)

CE: EMC directive: EN61326 compliance (Emission: Class A, Immunity: Annex A)

EN61000-3-2 compliant

EN61000-3-3 compliant

EN55011 compliant, Class A Group 1

Low voltage directive: EN61010-1 compliant, measurement category II, pollution degree 2

C-Tick: AS/NZS CISPR11 compliant, Class A Group 1

Comprehensive network functions

We have made the network functions more comprehensive. In addition to e-mail, Web server, and FTP functions, this model comes with time synchronization (SNTP), and automatic network configuration (DHCP). We have equipped this model with all of the latest network technology.

E-mail transmission functions

The MVAdvanced can send alarm information, periodic instantaneous values, report data, and other information via e-mail. The MVAdvanced also features a POP Before SMTP function for transmission authentication.

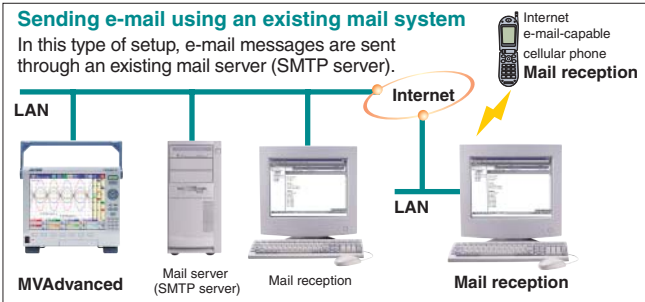

Easy monitoring via Web browser

The MVAdvanced has Web server features that make it easy to use a Web browser, such as Internet Explorer, to monitor the device and retrieve files stored in internal memory.

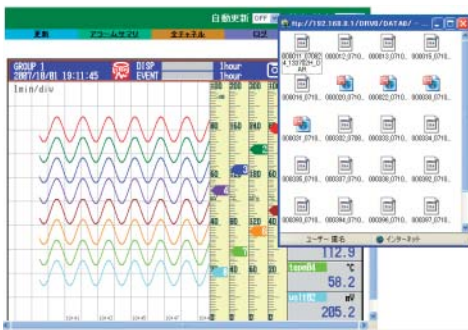

Time synchronization (SNTP) function

By using the SNTP client function, you can synchronize the time on the MVAdvanced to an SNTP server. You can also set up the MVAdvanced for use as an SNTP server.

File transfer using FTP

With the MVAdvanced's FTP server/client features, it is easy to use a fileserver for data sharing and centralized data management.

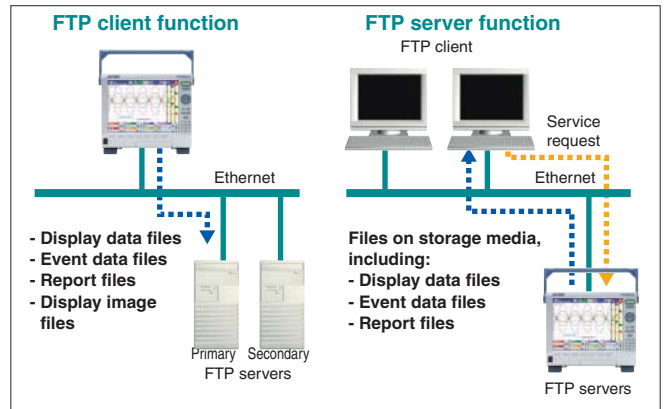

Automatic network configuration (DHCP)

The DHCP function makes it possible to set the IP Address and other network settings of the MVAdvanced automatically, thus making it easier to use the MVAdvanced on a network.

Modbus/TCP function Modbus/RTU function

You can connect the MVAdvanced to other devices and load/save data using the Modbus protocol.

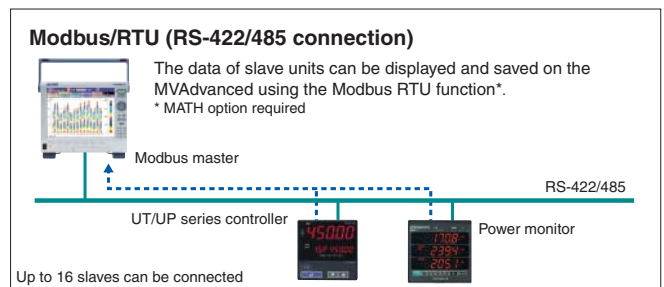

A rich variety of options and accessories

The MVAdvanced features a rich variety of options and accessories. Get the most out of the MVAdvanced by combining these options and accessories to suit your needs.

Rechargeable battery model (MV1000 only)

The rechargeable battery model is equipped with a battery that lasts for up to about 13 hours (3x times the duration of previous models). This enables you to acquire data in places where there is no power supply. (Note: The maximum period of continuous use will vary according to operating conditions.)



Vertical stand (MV1000 only)

A stand for installing the MVAdvanced vertically. Convenient when you place the MVAdvanced on the floor or other low-level places.



Calculation functions

In addition to basic arithmetic, it is possible to calculate the highest value within a set time period, the lowest value, the average value, and the integrated value. The results of these calculations can be produced in hourly, daily, or monthly reports.

Carrying case (MV1000/MV2000)

A soft carrying case for the MVAdvanced. Useful for business trips and any other time you change locations.



Block terminals (for use with clamp terminals)

These are removable terminals that are useful when connecting and disconnecting any kind of sensor. Extremely convenient for users who change sensors frequently.



Rack mounting bracket (MV1000/MV2000)

Bracket provided for installation on the 19-inch rack (JIS or ANSI).

Standard specifications

Weight and dimensions

MV1000 external dimensions:	189 (W) × 177 (H) × 259 (D)
MV1000 weight:	Approx. 3.5 kg (MV1024)
MV2000 external dimensions:	307 (W) × 273 (H) × 260 (D)
MV2000 weight:	Approx. 5.6 kg (MV2048)

Input components

Number of inputs:	MV1000: 4, 6, 8, 12, or 24 channels MV2000: 8, 10, 20, 30, 40 or 48 channels
Measurement intervals:	MV1004, MV1008, MV2008: 125 ms, 250 ms, or 25 ms in High-Speed mode MV1006, MV1012, MV1024, MV2010, MV2020, MV2030, MV2040, MV2048: 1 s (100 ms not possible for A/D integration time), 2 s, 5 s, or 125 ms in High-Speed mode * A/D integration time is fixed at 1.67 ms in High-Speed mode
Points to consider when using High-Speed mode:	When using High-Speed mode (an A/D integration time of 1.67 ms) with the MVAdvanced, power supply noise and other factors may cause the measured values to fluctuate. If this is the case, then measure using Normal mode (an A/D integration time of 16.7 ms, 20 ms, or 100 ms).
Input types:	DCV (DC voltage: 20, 60, 200 mV, 2, 6, 20, 50 V, 1-5 V) TC (thermocouple type: R, S, B, K, E, J, T, N, W, L, U, WRε) RTD (resistance temperature detector: Pt100, JPt100) DI (at the contact input or the TTL level) DCA (DC current; with external shunt resistor)
Measuring range, measurement accuracy, and display resolution by typical input type	

Input	Range	Measurement accuracy (when the integration time is 16.7 ms or more)	Display resolution
DCV	1-5 V	±(0.05% of rdg+3 digits)	1 mV
Thermocouple*	K	±(0.15% of rdg+0.7°C)	0.1°C
Resistance thermometer detector	Pt100	±(0.15% of rdg+0.3°C)	0.1°C

* Does not include the accuracy of reference junction compensation

Display

Display device:	MV1000: 5.5-inch TFT color LCD (320 × 240 dots) MV2000: 10.4-inch TFT color LCD (640 × 480 dots) Note: The LCD may contain some pixels that are always lighted or that never light, and variations in brightness may occur due to the characteristics of liquid crystals. Please note that these are not defects.
Display groups:	Number of display groups: MV1000: 10 groups, MV2000: 36 groups Maximum number of channels assignable per group: MV1000: 6 channels, MV2000: 10 channels
Displayed colors:	Trend/bar graph display: 24 available colors Background: White or black
Trend display:	Display types: Vertical, horizontal, horizontal wide, separated horizontal.
Bar graph display:	Direction: Vertical or horizontal
Digital display:	Update rate: 1 s
Overview display:	Channel number: Displays a list of all measurement and MATH channels along with their alarm states. Information display: Alarm Summary display, Message Summary display, Memory Summary display, Report display, Relay Condition display, Modbus Condition display
Log display:	Log display content: Log-in log, Error log, Transmission log, FTP log, Web log, E-mail log, SNMP log, DHCP log, Modbus log
Tag display:	Max. displayable characters: 16 Displayable characters: Alphanumeric characters
Message display:	Max. displayable characters: 32 Displayable characters: Alphanumeric characters Historical display function: Allows for the display of data stored to internal or external memory.
LCD screen saver function:	You can to dim or turn OFF the LCD backlight if there are no keystrokes for a set time (1, 2, 5, 10, 30 min, or 1 hour).
Display screen registration function:	You can assign a name to a display screen and register it. Max. registered screens: 8

Memory functions

External media:	Media: Compact Flash (CF) card
Internal memory:	Media: Flash memory Memory size: 400 MB
Sample time:	Examples of internal memory sample times (with the MV1012 recording only event data files for 12 measuring channels and no calculation channels).

Save interval	125 ms	1 s	5 s	10 s	60 s	120 s
Sample time (400 MB)	Approx. 18 days	Approx. 148 days	Approx. 2 years	Approx. 4 years	Approx. 24 years	Approx. 48 years

Max. savable data files:	400 (savable display data files and event data files combined)
Manual save:	Saves data files to the internal memory manually. You can save all data or only selected data. Destination drive: CF card or USB memory
Auto save:	Save displayed data: Saves data to the CF card at a set interval Save event data: Saves data to the CF card at a set interval (in Free Trigger mode) Save when finished sampling (when setting the trigger)
Data formats:	When saving to external media, both event data and display data can be saved in either binary or text format (data is always stored to internal memory in binary format).
Sampling interval:	Display data rate: Varies according to the waveform update rate Event data: User-set
Manual sample data:	You can choose when to save measurement/MATH channel data files to the internal memory or to a CF card.
Report data (only available if the unit is equipped with the calculation option):	Saves calculation results as data files to a CF card at the set times.
Types:	Hourly, daily, hourly + daily, daily + weekly, daily + monthly
Trigger function:	Data can be saved using Free mode or Trigger mode. When using Trigger mode, the user must set the data length, pre-trigger, and trigger source.
Snapshot function:	Saves the displayed screen image data to a CF card.
Data file loading:	Data files saved to a CF card or to USB memory (if equipped with the USB option) can be loaded and displayed. Loading and saving setup data: Settings data can be saved and loaded in Binary format.
USB interface:	USB specification 1.1 host
Ports:	2 (front and back)
Connectable devices:	Keyboards: 104 keyboards (US) compliant with USB HID Class Version 1.1 109 keyboards (Japanese) External media: USB memory (not all types of USB memory are guaranteed to work)

Alarm functions

Alarms settable per channel:	4
Alarm types:	High/low limit, delay high/low limit, difference high/low limit, high/low limit on rate of change
Delay alarm time:	Can be set according to channel (cannot be set according to level) Range: 1 to 3600 seconds
Time intervals for the rate-of-change alarm:	A factor of 1 to 32 times the measurement interval (applies to all channels)
Display:	When an alarm occurs, the state (the alarm type) or common alarm state appears on the digital display

Event action function

Description:	A set action occurs in response to a set event.
--------------	---

Security functions

Description:	You can customize key lock and login security functions for any transmission or keyboard command.
Key Lock:	Sets a password-protected key lock on all command keys and FUNC screen operations.
Login:	Limits access to the MVAdvanced with a login that prompts for username and password.
Security levels and user numbers:	System administrators: 5 General users: 30

Clock functions

Clock:	Comes with a calendar function (for the western calendar)
Clock accuracy:	±10 ppm (does not include the less than one second delay that occurs when turning the power on)

Communication functions (Ethernet)

Electrical specifications:	IEEE 802.3 compliant (DIX frame)
Transmission media:	Ethernet (10BASE-T)
Protocols implemented:	TCP, UDP, IP, ICMP, ARP, DHCP, HTTP, FTP, SMTP, SNMP, Modbus, and MV dedicated protocol
E-mail transmission functions (E-mail client):	Automatically sends an e-mail in response to alarms and other events.

FTP client functions:	Automatically sends data files to an FTP server Transmittable files: Display data files, event data files, report data files, screen snapshot data files
FTP server functions:	Can transfer and delete files, manipulate directories, and produce file lists remotely from a network computer.
Web server function:	Displays MV screen images on a Web browser.
SNTP client function:	Queries a specified SNTP server for the time and synchronizes with it. Time query methods: Set interval, start of memory sample, manual
SNTP server function:	Transmits the MV time settings via SNTP protocol.
DHCP client function:	Automatically retrieves the network address settings from a DHCP server. Information retrieved automatically: IP address, subnet mask, default gateway, DNS information
Modbus client function:	Loads data from other devices using Modbus protocol.* * The calculation option (M1) or the external input channel option (MC1) is required to load data.
Modbus server function:	Data can be read from the MV using the Modbus protocol.

Batch function

Description: Allows for data display, data management, text field functions, and batch comment input using batches.

Power supply

AC power supply:	Rated supply voltage: 100 to 264 VAC (auto switching)
DC power supply:	Rated supply voltage: 12 VDC/24 VDC
AC power supply:	Operating supply voltage range: 90 to 132, 180 to 264 VAC
DC power supply:	Operating supply voltage range: 10.0 to 28.8 VDC

Power consumption
MV1000 power consumption

Supply voltage	With LCD screen saver on	Normal use	Maximum
100 VAC	15 VA	30 VA	45 VA
240 VAC	25 VA	40 VA	60 VA
12 VDC	7 VA	14 VA	24 VA

MV2000 power consumption

Supply voltage	With LCD screen saver on	Normal use	Maximum
100 VAC	28 VA	40 VA	65 VA
240 VAC	38 VA	54 VA	90 VA
12 VDC	9 VA	18 VA	35 VA

Rechargeable battery drive (MV1000 only)
Powered by a dedicated AC adapter or the dedicated Ni-MH battery pack.
The dedicated Ni-MH battery pack can only be charged when connected to the main unit.
If both the AC adapter and battery pack are connected, the AC adapter will be used.

Continuous operation time
13 hours maximum (room temperature) under the following conditions: No USB connection; no option terminals; LCD backlight saver: OFF; transition time: 1 minute; external media saving: Auto-save.
Continuous operation time differs according to various conditions.

Normal operating conditions
Supply voltage: AC power supply: 90 to 132, 180 to 250 VAC
DC power supply: 10.0 to 28.8 VDC

Supply frequency: 50 Hz±2%, 60 Hz±2%
Ambient temperature: 0 to 40°C
Ambient humidity: 20 to 80% RH (at 5 to 40°C)

Optional specifications

- Alarm output relays (/A1, /A2, /A3, /A4)
Activates the relay output on the rear panel when an alarm occurs
Output points: Choose from 2, 4, 6, or 12*
* Only with the MV2000
Not installable on the MV1008 or MV1024
- Serial communication (/C2, /C3)
Media: EIA RS-232 (/C2) and RS-422/485 (four-wire) (/C3) compatible
Protocols implemented: The dedicated protocol and the Modbus (master/slave) protocol
Settings/measurement server functions:
Using the dedicated protocol, the following functions are available
Settings and commands equivalent to the unit's key commands.
Data output
Modbus master/slave functions: Loads data from other devices using Modbus protocol.*
* The calculation option (M1) or the external input channel option (MC1) is required to load data.
- Fail/status output relay (/F1)
Activates a relay output upon the detection of a CPU abnormality on the MV or a set condition.
- Calculation functions (M1)
Performs calculations as well as displays and records the trends or numeric values of calculation channels

Max. calculation channels:

listed below.
MV1004, MV1008: 12 channels
MV1006, MV1012, MV1024: 24 channels
MV2008: 12 channels
MV2010, MV2020, MV2030, MV2040, MV2048: 60 channels

Max. equation length:
Calculation types:

120 characters
General calculations: Basic arithmetic, square root, absolute value, common logarithm, natural logarithm, exponent, power, relational operations (<, ≤, >, ≥, =, ≠), logical operations (AND, OR, NOT, XOR)
Statistical calculations: TLOG (maximum value, minimum value, average value, integrated value, and P-P value for time series data)
CLOG (maximum value, minimum value, average value, integrated value, and P-P value for a set channel)
Special calculations: PRE, HOLD(a):b, RESET(a):b, CARRY(a):b
Conditional statement: [a?b:c]
Max. settable constants: 60 (K01 to K60)

Report function:

Report types: Hourly, daily, hourly + daily, daily + weekly, daily + monthly
Calculation types: Reports can be calculated using a combination of up to four of the following: Average, maximum value, minimum value, integrated value, and instantaneous value.

- Cu10/Cu25 RTD input/3-wire isolated RTD input (/N1)
Enables the use of Cu10 and Cu25 inputs in addition to the standard inputs.
- 3-wire isolated RTD input (/N2)
All RTD (resistance thermometer detector) terminals (A, B, and b) are isolated.
Note: Only available with the MV1006, MV1012, MV2010, MV2020, MV2030, MV2040, and MV2048
- External input (/N3)
Enables the use of the following thermocouples and RTDs in addition to the standard inputs.
TC: Kp vs Au7Fe, PLATINEL, PR40-20, NiNiMo, W/Wre26, TypeN(AWG14)
RTD: Pt25, Pt50, Ni100(SAMA), Ni100(DIN), Ni120, J263*B, Cu53, Cu100
- Remote control (/R1)
The MV can be controlled through contact input (up to 8 inputs can be set).
- 24 VDC transmitter power supply (/TPS2*, /TPS4*)
Output voltage: 22.8 to 25.2 VDC (for rated current load)
Rated output current: 4 to 20 mA DC
Maximum output current: 25 mA DC (overcurrent protection level: approximately 68 mA DC)
* /TPS2 is only available for the MV1000, /TPS4 is only available for the MV 2000
- Pulse input (/PM1)
Contact and open-collector pulse input is possible through the use of special remote input terminals.
The calculation functions (M1) and remote control (R1) options are included in the pulse input option.
Number of Inputs: 3 channels (however, if the remote control input terminals are used for pulse input, then up to 8 channels can be made available)
Input methods: Photocoupler isolation (no isolation between channels)
Internal isolated power supply (approx. 5 V)
Input types: Dry contact, open collector (TTL or transistor)
- Input value correction (/CC1)
Ten-segment linearizer approximation can be used on every measurement channel to correct input values.
Settable broken-line points: 2 to 16
- Channel expansion (/MC1, only available on the MV2000)
You can use the Modbus master function to load data from other devices, and set data through the use of communication input commands. Additional channels are provided for communication input.
Note 1: Only available with the MV2010, MV2020, MV2030, MV2040, and MV2048
Note 2: When equipped with the external input channel option, the High-Speed mode measurement interval is unavailable.
Number of external input channels: 240 channels (channel numbers 201 to 440)

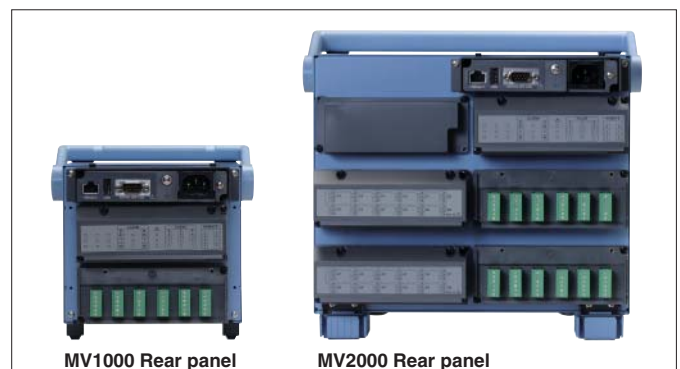

MODEL AND SUFFIX CODES

MV1000

Model code	Suffix code	Optional code	Description
MV1004			4 ch, 125 ms (Fast sampling mode: 25 ms)
MV1006			6 ch, 1 s (Fast sampling mode: 125 ms)
MV1008 ^{*9}			8 ch, 125 ms (Fast sampling mode: 25 ms)
MV1012			12 ch, 1 s (Fast sampling mode: 125 ms)
MV1024 ^{*9}			24 ch, 1 s (Fast sampling mode: 125 ms)
Internal Memory	-3		400 MB
External Media	-4		CF card (with Media) + USB
Language	-2		English/German/French
	-4		Korean
Input Terminal	-1		Clamped terminal
	-2		Screw terminal (M4)
Power Supply	-1		100 VAC, 240 VAC
	-2		12 VDC ^{*1}
	-3		Rechargeable battery ^{*1}
Power Cord	D		Power cord UL/CSA Standard
	F		Power cord VDE Standard
	R		Power cord SAA Standard
	Q		Power cord BS/PSB Standard ^{*11}
	H		Power cord GB Standard
	P		Power cord EK Standard ^{*10}
	W		without AC adapter, Power cord ^{*2}
Options	/A1		Alarm output 2 points ^{*3-9}
	/A2		Alarm output 4 points ^{*3-9}
	/A3		Alarm output 6 points ^{*3-4-9}
	/C2		RS-232 interface ^{*5}
	/C3		RS-422/485 interface ^{*5}
	/F1		FAIL/Status output ^{*4-9}
	/M1		Mathematical functions
	/N1		Cu10, Cu25 RTD input/3 leg isolated RTD
	/N2		3 leg isolated RTD ^{*6}
	/N3		Extended input type (PR40-20, Pt50, etc.)
	/R1		Remote control ^{*9}
	/TPS2		24 VDC transmitter power supply (2 loops) ^{*7-9}
	/PM1		Pulse input (including remote control and mathematical functions) ^{*8-9}
	/CC1		Calibration correction function

- *1 An AC adapter is included as a standard accessory. *2 W can be specified for only 12 VDC
 *3 /A1, /A2 and /A3 cannot be specified together. *4 /A3 and /F1 cannot be specified together.
 *5 /C2 and /C3 cannot be specified together. *6 /N2 can be specified for only MV1006, MV1012 and MV1024.
 *7 In case that /TPS2 is specified, /A2, /A3, /F1 and /PM1 cannot be specified together.
 *8 In case that /PM1 is specified, /A3, /M1, /R1 and /TPS2 cannot be specified together. And combination of /A2/F1 cannot be specified together.
 *9 In case that MV1008, MV1024 is specified, /A1, /A2, /A3, /F1, /R1, /TPS2 and /PM1 cannot be specified.
 *10 In case that 100 VAC, 240 VAC is specified, P cannot be specified together.
 *11 BS standard is specified only 100 VAC, 240 VAC

MV2000

Model code	Suffix code	Optional code	Description
MV2008			8 ch, 125 ms (Fast sampling mode: 25 ms)
MV2010			10 ch, 1 s (Fast sampling mode: 125 ms)
MV2020			20 ch, 1 s (Fast sampling mode: 125 ms)
MV2030			30 ch, 1 s (Fast sampling mode: 125 ms)
MV2040			40 ch, 1 s (Fast sampling mode: 125 ms)
MV2048			48 ch, 1 s (Fast sampling mode: 125 ms)
Internal memory	-3		400 MB
External Media	-4		CF card (with Media)+USB
Display Language	-2		English/German/French
	-4		Korean
Input Terminal	-1		Clamped terminal
	-2		Screw terminal (M4)
Power Supply	-1		100 VAC, 240 VAC
	-2		12 VDC ^{*1}
Power Cord	D		Power cord UL/CSA Standard
	F		Power cord VDE Standard
	R		Power cord SAA Standard
	Q		Power cord BS/PSB Standard ^{*11}
	H		Power cord GB Standard
	P		Power cord EK Standard ^{*10}
	W		without AC adapter, Power cord ^{*2}
Options	/A1		Alarm output 2 points ^{*3}
	/A2		Alarm output 4 points ^{*3}
	/A3		Alarm output 6 points ^{*3}
	/A4		Alarm output 12 points ^{*3-4}
	/C2		RS-232 interface ^{*5}
	/C3		RS-422/485 interface ^{*5}
	/F1		FAIL/Status output ^{*4}
	/M1		Mathematical function
	/N1		Cu10, Cu25 RTD input /3 leg isolated RTD
	/N2		3 leg isolated RTD ^{*6}
	/N3		Extended input type (PR40-20, Pt50, etc.)
/R1		Remote control	
/TPS4		24 VDC transmitter power supply (4 loops) ^{*7}	
/PM1		Pulse input (including remote control and mathematical functions) ^{*8}	
/CC1		Calibration correction function	
/MC1		External input function ^{*9}	

- *1 An AC adapter is included as a standard accessory. *2 W can be specified for only 12 VDC
 *3 /A1, /A2, /A3 and /A4 cannot be specified together. *4 /A4 and /F1 cannot be specified together.
 *5 /C2 and /C3 cannot be specified together. *6 /N2 can be specified for only MV2010, MV2020, MV2030, MV2040 and MV2048.
 *7 In case that /TPS4 is specified, /A4 cannot be specified together. And combination of /A3/F1 cannot be specified together.
 *8 In case that /PM1 is specified, /A4, /M1, /R1 cannot be specified together. And combination of /A2/F1 and /A3/TPS4 cannot be specified together.
 *9 /MC1 can be specified for only MV2010, MV2020, MV2030, MV2040 and MV2048.
 *10 In case that 100 VAC, 240 VAC is specified, P cannot be specified together.
 *11 BS standard is specified only 100 VAC, 240 VAC

STANDARD ACCESSORIES

Product	Qty.
DAQSTANDARD	1
Terminal Screw	5
Instruction manual (First step guide: by paper)	1
Instruction manual (Mainunit/commuication/DAQSTANDARD: CD-ROM)	1
128 MB CF CARD	1
Power cord	1 ^{*1}
AC adapter + Power cord	1 ^{*2}

- *1 100 VAC/240 VAC Power supply (When the "-1" Power supply specification code is specified)
 *2 12 VDC Power supply (When specified the "-2" Power supply specification code) or Rechargeable battery (When specified the "-3" Power supply specification code)

ACCESSORIES

Product	Code (Parts NO.)	Specification
Shunt resistor (For screw input terminal)	415920	250Ω±0.1%
	415921	100Ω±0.1%
	415922	10Ω±0.1%
Shunt resistor (For clamped input terminal)	438920	250Ω±0.1%
	438921	100Ω±0.1%
	438922	10Ω±0.1%
CF card adapter (not including CFcard)	772090	
CF CARD (not including adapter)	772093	512 MB
	772094	1 GB
Soft carrying case	790501	For MV1000
	701964	For MV2000
Rack mount bracket (JIS)	B8805JU	For MV1000
Rack mount bracket (ANSI)	B8805JT	For MV1000
Rack mount bracket (JIS)	B8806JU	For MV2000
Rack mount bracket (ANSI)	B8806JT	For MV2000
Vertical stand	B8805JL	For MV1000
Battery Pack	B8805HA	Using for Battery model
Removable clamped input terminal	A1923JT	for 2 channels

APPLICATION SOFTWARE

Model code	Description	OS
DXA120	DAQSTANDARD	Windows2000, XP, Vista

DIMENSIONS

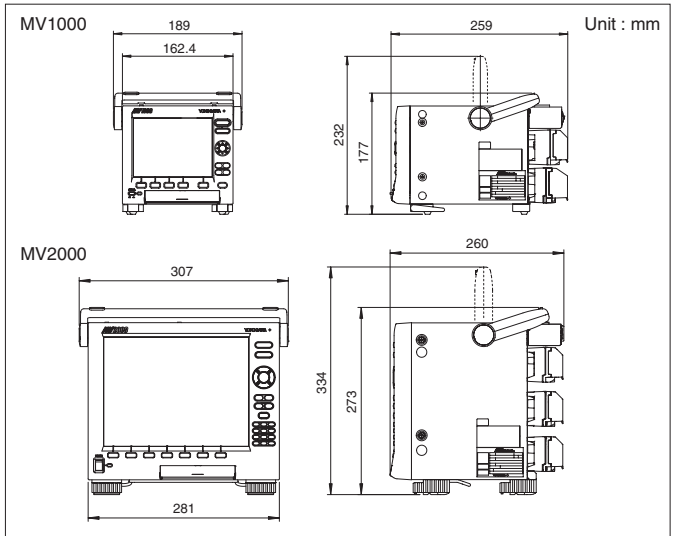

NOTICE

- Before operating the product, read the user's manual thoroughly for proper and safe operation.
- If this product is for use with a system requiring safeguards that directly involve personnel safety, please contact the Yokogawa sales offices.

YOKOGAWA

YOKOGAWA ELECTRIC CORPORATION

Network Solutions Business Div./Phone: (81)-422-52-7179, Fax: (81)-422-52-6619

E-mail: ns@cs.jp.yokogawa.com

YOKOGAWA CORPORATION OF AMERICA

YOKOGAWA EUROPE B.V.

YOKOGAWA ENGINEERING ASIA PTE. LTD.

Phone: 800-258-2552, Fax: (1)-770-254-0928

Phone: (31)-88-4641000, Fax: (31)-88-4641111

Phone: (65)-62419933, Fax: (65)-62412606

NetSol Online

Sign up for our free e-mail newsletter
www.yokogawa.com/ns/

Subject to change without notice.

[Ed : 04/b] Copyright ©2007

Printed in Japan, 001(KP)